

INNOVATION LIVING™



THE DANISH SOFA BED SPECIALIST ESTABLISHED IN 1971



# WE WOULD LIKE TO EXPAND YOUR LIVING SPACE IN STYLE

Innovation Living™ is a Danish sofa bed specialist built on the proud Danish tradition of furniture design. We believe that form and function must go hand in hand to create innovative, durable designs for everyday use.

Since 1971, we have dedicated ourselves to the design and development of multifunctional sofa beds, and today we are proud to be able to call Innovation Living™ an internationally renowned sofa bed specialist.



ATTENTION TO INCOMPARABLE QUALITY AND SUSTAINABILITY IS YOUR ASSURANCE OF EXCELLENCE

As consumers, we are obliged to reassess our consumption habits. Our collective will to prioritize durable quality products that we want to retain over time is crucial, as it is the most efficient way to minimize resource consumption and pollution.

As a global supplier of upholstered furniture, our commitment lies in crafting products that are optimized for both aesthetics and quality, ensuring a prolonged lifespan.

Our designs are made to withstand the test of time and come with our 5-year limited warranty for peace of mind.

An Innovation Living™ product goes beyond furniture, it represents a lasting investment in design, comfort, and durability.

GROWING A GREENER FUTURE

In an effort to contribute positively to the balance of the global ecosystem and mitigate the environmental impact of our operations, we have instituted a comprehensive reforestation initiative.

Recognizing the critical importance of sustainable resource management, particularly concerning wood consumption, we are committed to planting in excess of 10,000 trees annually.

This initiative goes beyond offsetting our consumption. It is a tangible expression of our commitment to environmental stewardship and promotion of biodiversity. The selection and planting of trees are conducted under the strict supervision of a certified forester.



# CONTENTS

AMERICAN CONTEMPORARY	The Neah Family	6
	The Vilander Family	14
	The Carnell Family	22
EUROPEAN CONTEMPORARY	The Newilla Family	30
	Osvald & Cornila	40
	Cone & Cornila	42
	Tripi & Cornila	46
	Cassius D.E.L.	48
	Supremax D.E.L.	52
	Grand D.E.L.	54
	Malloy	56
	Cubed With Arms	60
	Cubed Chrome	64
Dublexo Stainless Steel With Arms	66	
SCANDINAVIAN	Dublexo Frej	70
	Dublexo Eik	74
	Cubed Dark Wood	76
	Ran D.E.L.	80
MID-CENTURY MODERN	Dublexo Styletto	84
	Zeal	88
	Recast	90
	Unfurl	92
ABOUT	Designed With Purpose	28
	Sustainable Practices	68
	Curated Fabrics	82
	Comfort & Quality	94
	Fabric Collection	98



# THE NEAH FAMILY







NEAH WITH STANDARD ARMS

Design by Per Weiss 2023

Bed size 63"x77" | Metal frame with Double Spring comfort, see page 96 | Shown in 365 Halifax Shell (Performance fabric) | Shown fabrics: 2-4 weeks delivery time | Other fabric options with 12-14 weeks delivery time, see pages 98-99 | Scan the QR code to see additional features on our website.

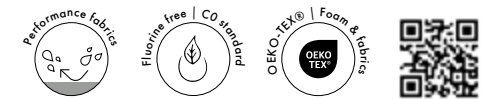
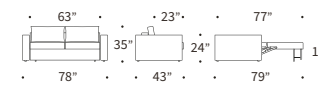



NEAH WITH CURVED ARMS

Design by Per Weiss 2023

Bed size 71"x77" | Metal frame with Double Spring comfort, see page 96 | Shown in 367 Halifax Wicker (Performance fabric) | Shown fabrics: 2-4 weeks delivery time | Other fabric options with 12-14 weeks delivery time, see pages 98-99 | Scan the QR code to see additional features on our website.

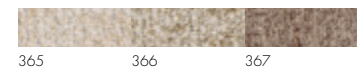
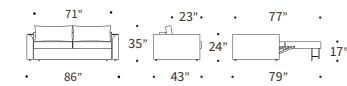





Explore the Neah family and elevate your lifestyle.

Neah's versatility is enhanced by its size and design options. Choose from three sizes, three distinct arm styles and a selection of fabric options. Choose the Slim arms for compact spaces, Standard arms for a classic look, or Curved arms for a touch of sophistication. Neah seamlessly integrates with any interior design vision.

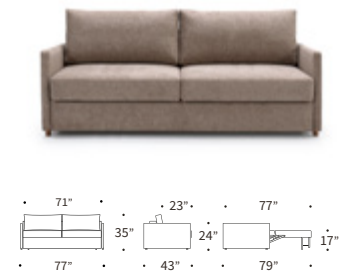
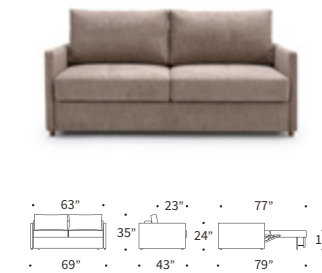
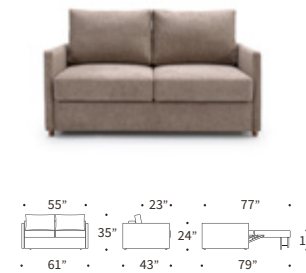

Neah | Slim arms

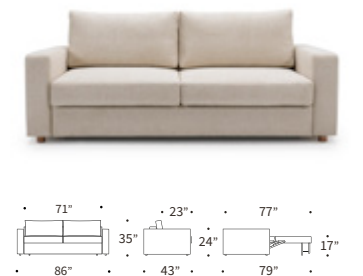
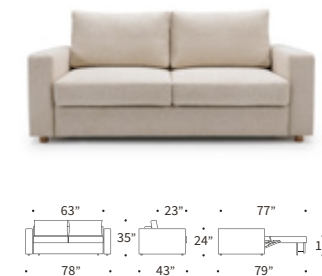
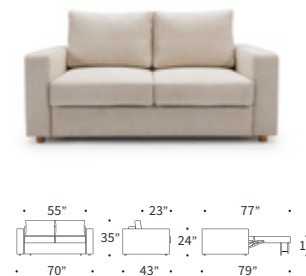

Neah | Standard arms

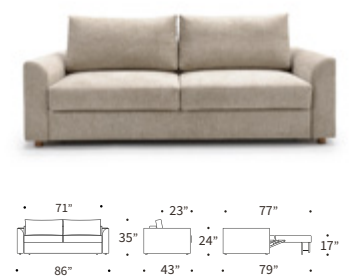
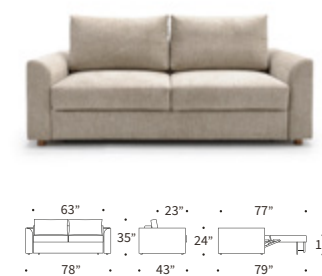
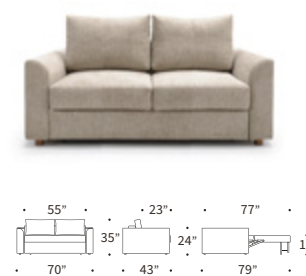

Neah | Curved arms

NEAH WITH SLIM ARMS

Design by Per Weiss 2023

Bed size 55"x77" | Metal frame with Double Spring comfort, see page 96 | Shown in 366 Halifax Antique (Performance fabric) | Shown fabrics: 2-4 weeks delivery time | Other fabric options with 12-14 weeks delivery time, see pages 98-99 | Scan the QR code to see additional features on our website.

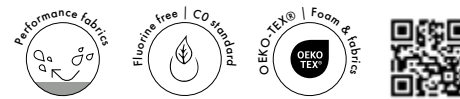
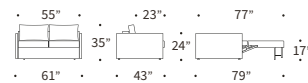



# THE VILANDER FAMILY







### VILANDER WITH CUSHION ARMS

Design by Per Weiss 2024

Bed size 57"x79" | Metal frame with Double Spring comfort, see page 96 | Shown in 357 Taura Off White | Shown fabrics: 2-4 weeks delivery time | Other fabric options with 12-14 weeks delivery time, see pages 98-99 | Scan the QR code to see additional features on our website.

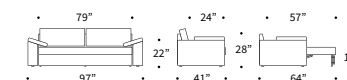



### VILANDER WITH ROLL ARMS

Design by Per Weiss 2024

Bed size 57"x79" | Metal frame with Double Spring comfort, see page 96 | Shown in 282 Avella Warm Grey | Shown fabrics: 2-4 weeks delivery time | Other fabric options with 12-14 weeks delivery time, see pages 98-99 | Scan the QR code to see additional features on our website.

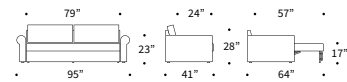
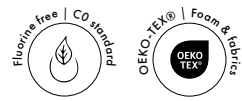



### VILANDER WITH WIDE ARMS

Design by Per Weiss 2024

Bed size 57"x79" | Metal frame with Double Spring comfort, see page 96 | Shown in 281 Avella Pine Green | Two arm trays included | Shown fabrics: 2-4 weeks delivery time | Other fabric options with 12-14 weeks delivery time, see pages 98-99 | Scan the QR code to see additional features on our website.

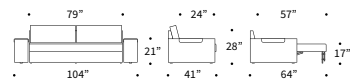
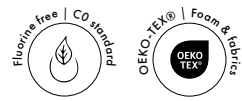



AMERICAN CONTEMPORARY

# THE CARNELL FAMILY







### CARNELL WITH SLOPE ARMS

Design by Per Weiss 2024

Bed size: 63"x77" | Metal frame with Dual Memory mattress, see page 96 | Shown in 257 Adario Taupe (Performance fabric) | Shown fabrics: 2-4 weeks delivery time | Other fabric options with 12-14 weeks delivery time, see pages 98-99 | Scan the QR code to see additional features on our website.

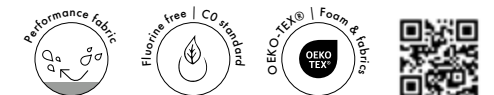



CARNELL WITH STANDARD ARMS

Design by Per Weiss 2024

Bed size: 63"x77" | Metal frame with Dual Memory mattress, see page 96 | Shown in 351 Taura Slate Grey | Shown fabrics: 2-4 weeks delivery time | Other fabric options with 12-14 weeks delivery time, see pages 98-99 | Scan the QR code to see additional features on our website.

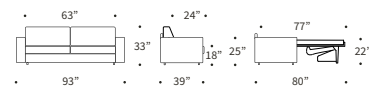



# THERE IS AN INTENTION BEHIND EVERY DESIGN

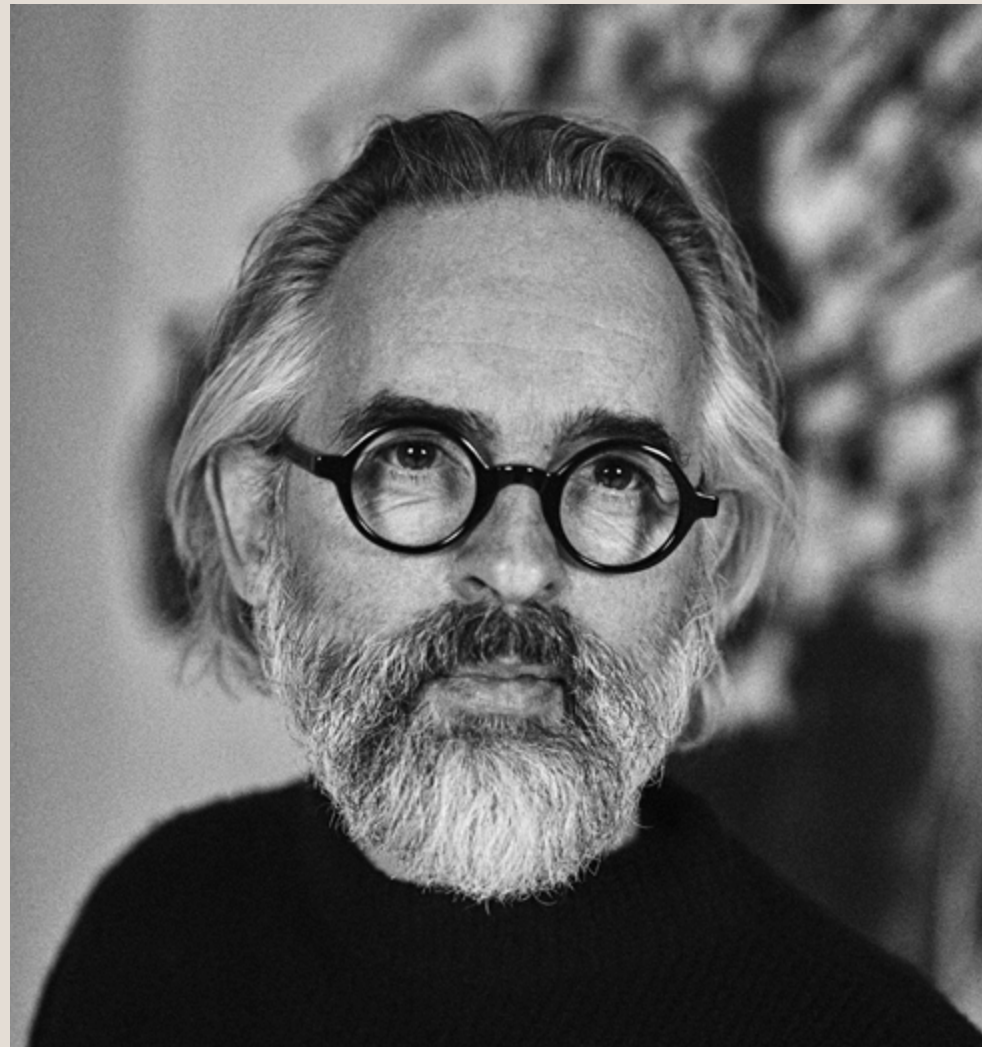

Per Weiss

Chief Design Officer  
Innovation Living Design Office

The Danish designer Per Weiss is the Chief Design Officer at Innovation Living™. He has been a part of Innovation Living™ since 1989 and is the driving force behind the constant creative development of the collections.

Based on the Scandinavian design tradition, Per is always striving to create durable designs that reflect zeitgeist - attractive designs that will make a positive difference in everyday life.



Emil Højfeldt  
Chief Production Officer



Oliver & Lukas WeissKrogh  
Studio WeissKrogh



Flemming Højfeldt  
Founder of Innovation Living™



Andreas Lund  
Industrial Designer



# THE NEWILLA FAMILY







NEWILLA LOUNGER WITH STANDARD ARMS

Design by Per Weiss 2022

Bed size: 57"x79"/118" | Solid wood frame with No-zag and Pocket Spring comfort, see page 96 | Lounger is left/right reversible | Detachable covers | Integrated storage | Shown in 257 Adario Taupe (Performance fabric) | Shown fabrics: 2-4 weeks delivery time | Other fabric options with 12-14 weeks delivery time, see pages 98-99 | Scan the QR code to see additional features on our website.

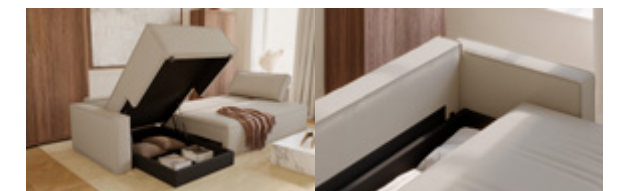
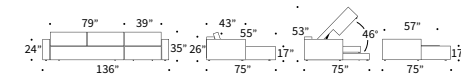

Integrated storage in lounger

Integrated storage in sofa





NEWILLA WITH SLIM ARMS

Design by Per Weiss 2022

Bed size: 57"x79" | Solid wood frame with No-zag and Pocket Spring comfort, see page 96 | Detachable covers | Integrated storage | Shown in 256 Adario Fog (Performance fabric) | Shown fabrics: 2-4 weeks delivery time | Other fabric options with 12-14 weeks delivery time, see pages 98-99 | Scan the QR code to see additional features on our website.



Integrated storage in sofa

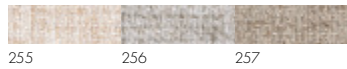
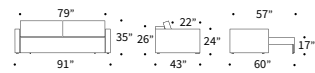





### NEWILLA WITH WIDE ARMS

Design by Per Weiss 2022

Bed size: 57"x79" | Solid wood frame with No-zag and Pocket Spring comfort, see page 96 | Detachable covers | Two arm trays included | Integrated storage | Shown in 255 Adario Basmati (Performance fabric) | Shown fabrics: 2-4 weeks delivery time | Other fabric options with 12-14 weeks delivery time, see pages 98-99 | Scan the QR code to see additional features on our website.

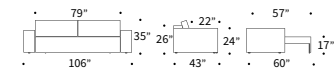

Integrated storage in sofa



Performance fabric | Flame free | CO standard | OEKO-TEX® | Foam & fabric | Bedding box | Detachable covers





Versatility meets elegance with Newilla.

This exceptional sofa offers three distinct arm designs tailored to your preferences. Choose the Slim arms for compact spaces, the Standard arms for a classic touch, or the Wide arms featuring walnut wood trays, transforming the armrests into functional side tables, for a contemporary look. The choice is yours, and each design adds a touch of sophistication to your living space. To add the reversible lounger, simply insert it left or right between the sofa and armrests, and create a stylish sectional sofa ideal for any modern living room setting.

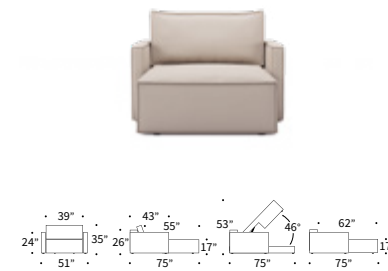

Newilla Lounger Chair | Slim arms

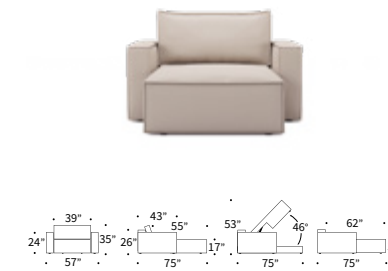

Newilla Lounger Chair | Standard arms

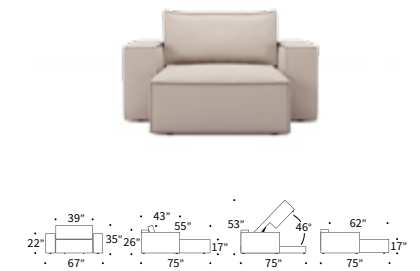

Newilla Lounger Chair | Wide arms

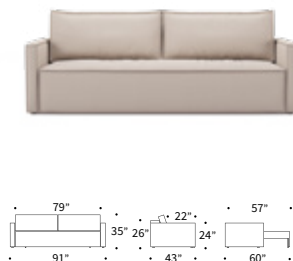

Newilla | Slim arms

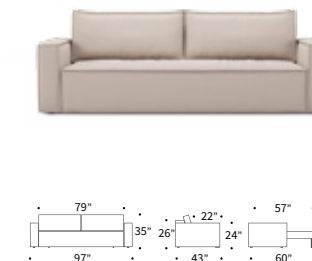

Newilla | Standard arms

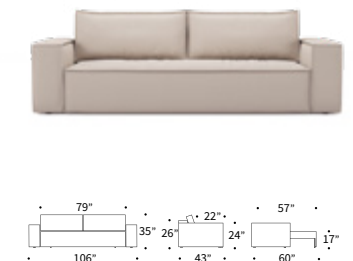

Newilla | Wide arms

NEWILLA LOUNGER CHAIR WITH STANDARD ARMS

Design by Per Weiss 2022

Chair/Lounger size: 39"x62" | Solid wood frame with No-zag and Pocket Spring comfort, see page 96 | Detachable covers | Integrated storage | Shown in 257 Adario Taupe (Performance fabric) | Shown fabrics: 2-4 weeks delivery time | Other fabric options with 12-14 weeks delivery time, see pages 98-99 | Scan the QR code to see additional features on our website.

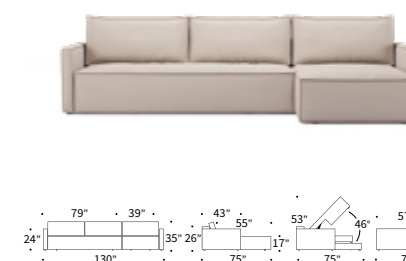
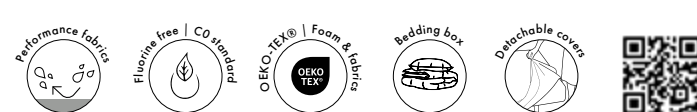
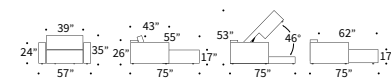

Newilla Lounger | Slim arms

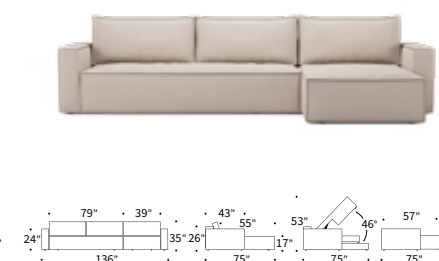

Newilla Lounger | Standard arms

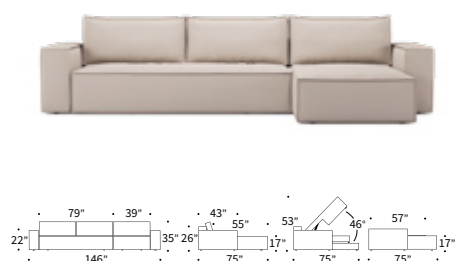

Newilla Lounger | Wide arms



OSVALD & CORNILA

Design by Emil Højfeldt & Per Weiss 2015, 2018

Bed size: 59"x79" | Ottoman size: 30"x30" | Metal frame with Pocket Spring Dual comfort, see page 95 | Storage in sofa bed & ottoman | Shown in 579 Kenya Gravel | Shown fabrics: 2-4 weeks delivery time | Other fabric options with 12-14 weeks delivery time, see pages 98-99 | Scan the QR code to see additional features on our website.



Integrated storage in sofa



Cornila ottoman

Integrated storage

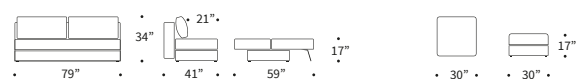



# CONE







Cornila ottoman

Integrated storage

Integrated storage in sofa

## CONE & CORNILA

Design by Emil Højfeldt & Per Weiss 2015, 2018, 2024

Bed size: 59"x79" | Ottoman size: 30"x30" | Metal frame with Pocket Spring Dual comfort, see page 95 | Storage in sofa bed & ottoman | Shown in 282 Avella Warm Grey | Shown fabrics: 2-4 weeks delivery time | Other fabric options with 12-14 weeks delivery time, see pages 98-99 | Scan the QR code to see additional features on our website.

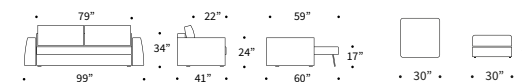



TRIPi & CORNILA

Design by Emil Højfeldt & Per Weiss 2015, 2016, 2018

Bed size: 59"x79" | Ottoman size: 30"x30" | Metal frame with Pocket Spring Dual comfort, see page 95 | Storage in sofa bed & ottoman | Shown in 538 Melange Grey | Shown fabrics: 2-4 weeks delivery time | Other fabric options with 12-14 weeks delivery time, see pages 98-99 | Scan the QR code to see additional features on our website.



Integrated storage in sofa



Cornila ottoman

Integrated storage

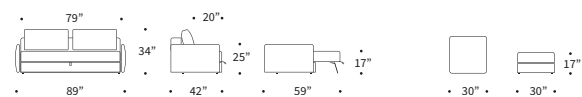



# CASSIUS D.E.L.







CASSIUS D.E.L.

Design by Per Weiss 2008

Bed size: 63"x79" | Ottoman size: 26"x26" | Metal frame with Excess Pocket Spring comfort, see page 95 | Legs in chromed steel | Shown in 538 Melange Grey | Shown fabrics: 2-4 weeks delivery time | Other fabric options with 12-14 weeks delivery time, see pages 98-99 | Scan the QR code to see additional features on our website.

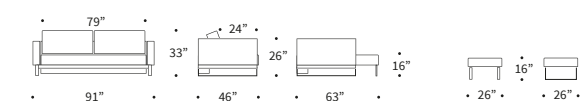



SUPREMAX D.E.L.

Design by Per Weiss 2008

Bed size: 63"x79" | Ottoman size: 26"x26" | Metal frame with Excess Pocket Spring comfort, see page 95 | Legs in chromed steel | Shown in 527 Mixed Dance Natural | Shown fabrics: 2-4 weeks delivery time | Other fabric options with 12-14 weeks delivery time, see pages 98-99 | Scan the QR code to see additional features on our website.

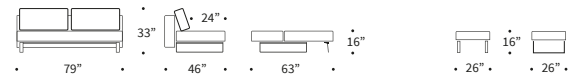
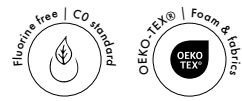



GRAND D.E.L.

Design by Per Weiss 2015

Bed size: 63"x79" | Ottoman size: 26"x26" | Metal frame with Excess Pocket Spring comfort, see page 95 | Legs in black stained wood | Two arm trays included | Shown in 528 Mixed Dance Blue | Shown fabrics: 2-4 weeks delivery time | Other fabric options with 12-14 weeks delivery time, see pages 98-99 | Scan the QR code to see additional features on our website.

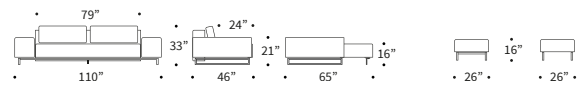
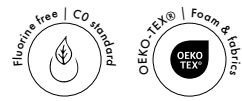



# MALLOY







### MALLOY

Design by Per Weiss 2020

Bed size: 59"x79" | Ottoman size: 30"x39" | Metal frame with Pocket Spring Dual comfort, see page 95 | Legs in matt black steel | Bedding box | Shown in 579 Kenya Gravel | Shown fabric: 2-4 weeks delivery time | Other fabric options with 12-14 weeks delivery time, see pages 98-99 | Scan the QR code to see additional features on our website.



579

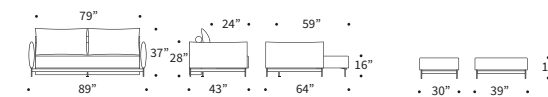



EUROPEAN CONTEMPORARY

# CUBED WITH ARMS







CUBED WITH ARMS

Design by Per Weiss 2009, 2015

Bed sizes: 55"x79" & 63"x79" | Solid wood frame with No-zag Spring comfort, see page 96 | Legs in matt black steel | Bedding box | Shown in 521 Mixed Dance Grey | Shown fabrics: 2-4 weeks delivery time | Other fabric options with 12-14 weeks delivery time, see pages 98-99 | Scan the QR code to see additional features on our website.

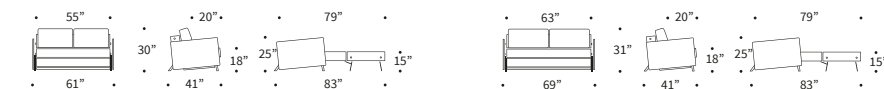



CUBED CHROME

Design by Per Weiss 2009

Bed sizes: 55"x79" & 63"x79" | Solid wood frame with No-zag Spring comfort, see page 96 | Legs in chromed steel | Bedding box | Shown in 521 Mixed Dance Grey | Shown fabrics: 2-4 weeks delivery time | Other fabric options with 12-14 weeks delivery time, see pages 98-99 | Scan the QR code to see additional features on our website.

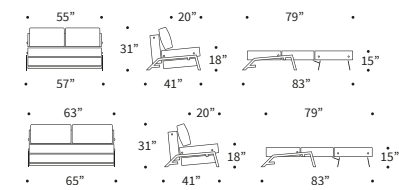



DUBLEXO STAINLESS STEEL WITH ARMS

Design by Per Weiss 2011

Bed size: 45"x83" | Chair/Lounger size: 45"x35" | Metal frame with Pocket Spring Dual comfort, see page 95 | Legs in stainless steel | Shown in 506 Elegance Paprika | Shown fabrics: 2-4 weeks delivery time | Other fabric options with 12-14 weeks delivery time, see pages 98-99 | Scan the QR code to see additional features on our website.

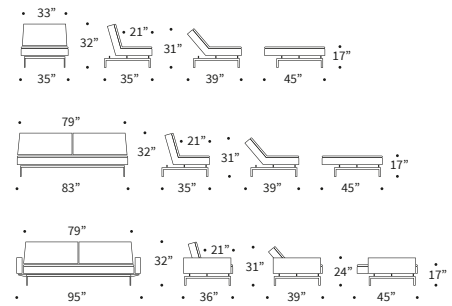
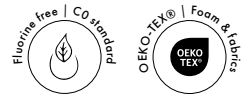



# SUSTAINABLE PRACTICES

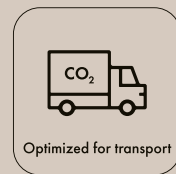

Our designs and packaging are optimized to lower CO<sub>2</sub> emissions during transport and storage.



We select materials and develop designs with sustainability, disassembly, and recirculation in mind.



Our production facilities are FSC®-certified and in addition we plant more than 10.000 trees yearly to compensate for the wood we use.



We offer a 5-year limited warranty, as we want to ensure that all our products have a prolonged lifespan.



Amfori BSCI enhances global supply chain social compliance via a common code.

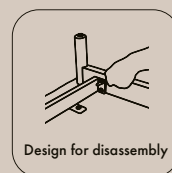

Our design strategy allows for easy replacement of components to prolong a product's life cycle.

# OEKO-TEX® CERTIFIED



All of our foam and fabrics are OEKO-TEX® certified.

OEKO-TEX® is one of the world's best-known labels for textiles that have been tested for harmful substances to ensure customer confidence and high product safety. By adhering to this certification, we demonstrate our unwavering dedication to producing safe, high-quality, and environmentally responsible furniture for our customers.

The stringent criteria of OEKO-TEX® for testing against harmful substances include:

- Compliance with important legal regulations, such as banned azo colorants, pentachlorophenol, per-fluorinated substances (PFAS, PFCs), cadmium, lead, etc.
- Testing for numerous harmful chemicals, even if they are not yet regulated legally.
- The certification criteria cover numerous substance classes that are relevant to the environment.
- Compliance with several global regulations, including REACH Annex XIV and XVII, US CPSIA (lead), EU POPs regulation.
- All textile-relevant substances of the ECHA SVHC candidate list are covered.



# DUBLEXO FREJ







DUBLEXO FREJ SMOKED OAK & DUBLEXO EIK SMOKED OAK

Design by Per Weiss, Oliver & Lukas WeissKrogh 2011, 2015

Bed size: 45"x83" | Chair/Lounger size: 45"x35" | Metal frame with Pocket Spring Dual comfort, see page 95 | Arms & legs in smoked oak | Shown in 527 Mixed Dance Natural | Shown fabrics: 2-4 weeks delivery time | Other fabric options with 12-14 weeks delivery time, see pages 98-99 | Scan the QR code to see additional features on our website.

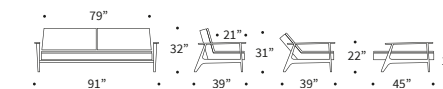
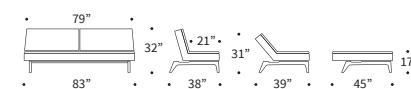
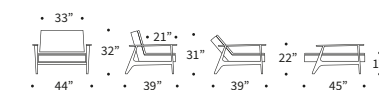
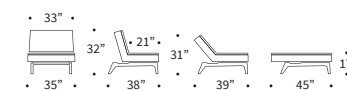



DUBLEXO EIK SMOKED OAK

Design by Per Weiss, Oliver & Lukas WeissKrogh 2011, 2015

Bed size: 45"x83" | Chair/Lounger size: 45"x35" | Metal frame with Pocket Spring Dual comfort, see page 95 | Legs in smoked oak | Shown in 521 Mixed Dance Grey | Shown fabrics: 2-4 weeks delivery time | Other fabric options with 12-14 weeks delivery time, see pages 98-99 | Scan the QR code to see additional features on our website.

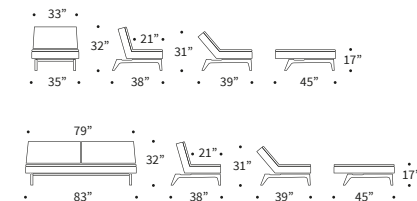
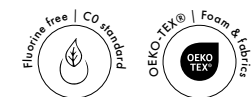



SCANDINAVIAN

77

# CUBED DARK WOOD







CUBED DARK WOOD

Design by Per Weiss, Oliver & Lukas WeissKrogh 2009, 2015

Bed sizes: 55"x79" & 63"x79" | Solid wood frame with No-zag Spring comfort, see page 96 | Legs in dark lacquered oak | Bedding box | Shown in 527 Mixed Dance Natural | Shown fabrics: 2-4 weeks delivery time | Other fabric options with 12-14 weeks delivery time, see pages 98-99 | Scan the QR code to see additional features on our website.

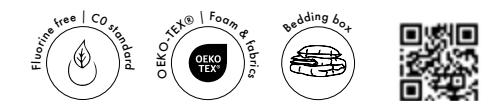
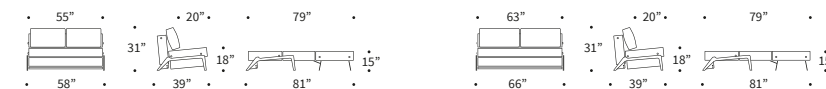



RAN D.E.L.

Design by Per Weiss, Oliver & Lukas WeissKrogh 2016

Bed size: 63"x79" | Metal frame with Excess Pocket Spring comfort, see page 95 | Arms & legs in walnut veneer | Shown in 527 Mixed Dance Natural | Shown fabrics: 2-4 weeks delivery time | Other fabric options with 12-14 weeks delivery time, see pages 98-99 | Scan the QR code to see additional features on our website.

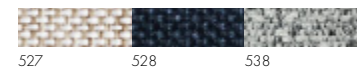
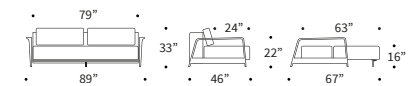



# CURATED FABRICS

At the heart of each design lies the fabric covering, a pivotal element influencing both aesthetics and durability. We carefully curate our fabric assortment, blending the latest trends with enduring commercial fabrics to offer a diverse range of options.

Each fabric undergoes rigorous testing by independent and accredited laboratories for durability, colorfastness, pilling, and other essential factors to ensure longevity and performance. Crafted primarily from polyester fibers, our fabrics boast exceptional strength and resilience.

For added functionality, we present a selection of performance fabrics engineered to safeguard against spills and stains, enhancing the lifespan of your furniture. Moreover, our fabrics are fluorine-free and OEKO-TEX® certified, prioritizing sustainability and safety.





# DUBLEXO STYLETTO







DUBLEXO STYLETTO DARK WOOD WITH ARMS

Design by Per Weiss 2011

Bed size: 45"x83" | Chair/Lounger size: 45"x35" | Metal frame with Pocket Spring Dual comfort, see page 95 | Legs in dark lacquered oak | Shown in 527 Mixed Dance Natural | Shown fabrics: 2-4 weeks delivery time | Other fabric options with 12-14 weeks delivery time, see pages 98-99 | Scan the QR code to see additional features on our website.

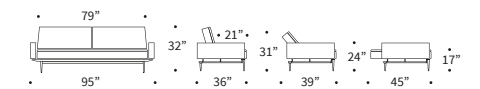
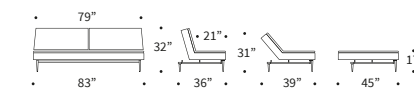
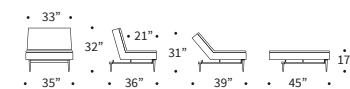



ZEAL

Design by Per Weiss 2013

Bed size: 28"x79" | Metal frame with Pocket Spring comfort, see page 95 | Styletto legs in dark lacquered oak | Shown in 281 Avella Pine Green | Shown fabrics: 2-4 weeks delivery time | Other fabric options with 12-14 weeks delivery time, see pages 98-99 | Scan the QR code to see additional features on our website.

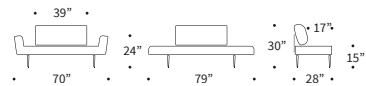
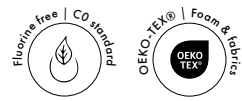



RECAST DARK STYLETTO WITH ARMS

Design by Per Weiss 2011, 2015

Bed size: 55"x79" | Metal frame with Pocket Spring comfort, see page 95 | Legs in dark lacquered oak | Arms in walnut veneer | Bedding box | Shown in 366 Halifax Antique (Performance fabric) | Shown fabrics: 2-4 weeks delivery time | Other fabric options with 12-14 weeks delivery time, see pages 98-99 | Scan the QR code to see additional features on our website.

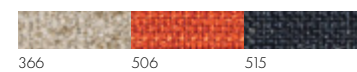
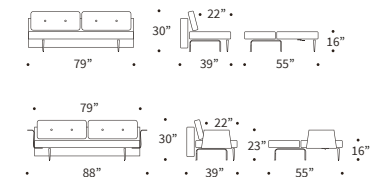
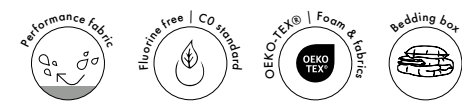





### UNFURL

Design by Andreas Lund, Flemming Højfeldt & Per Weiss 2004

Bed size: 47"x79" | Metal frame with Pocket Spring comfort, see page 95 | Styletto legs in dark lacquered oak | Shown in 507 Elegance Burned Curry | Shown fabrics: 2-4 weeks delivery time | Other fabric options with 12-14 weeks delivery time, see pages 98-99 | Scan the QR code to see additional features on our website.

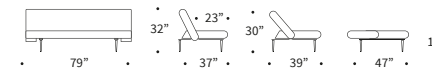



## COMFORT IS ALWAYS AT THE CENTER OF OUR ATTENTION



In the development of our multifunctional sofas, we prioritize both seating and sleeping comfort while adhering to functional principles. Each design introduces unique challenges in achieving the optimal level of comfort. Our goal is to present a diverse assortment that acknowledges the significant variations in individual comfort preferences.

To this end, our product range extends from sleek, elegantly designed sofas offering a firmer comfort level to larger, more voluminous options characterized by softer comfort. This approach ensures that we cater to the varied tastes and needs of our customers, providing them with a selection that meets their specific comfort requirements.

### POCKET SPRING

The individual pockets in these models ensure that pressure is applied to each individual spring for optimal support – in seating as well as sleeping position. The high resilient foam casing contributes to a breathable mattress while providing a soft top support.

The following models have this comfort:  
Recast, Unfurl, Zeal

Fabric  
Fiberfill  
High resilient foam  
Pocket spring 2½"-5"  
Fibertex  
Metal mesh  
Rigid metal frame

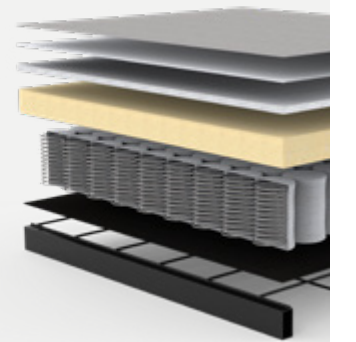

### POCKET SPRING DUAL

The Pocket Spring Dual comfort share the general composition of the Pocket Spring models apart from the extra layer of hyper soft foam that gives these sofa beds an extra soft feel. This extra layer of luxury provides a soft seating and sleeping comfort.

The following models have this comfort:  
Dublexo, Cone, Cornila, Malloy, Osvald, Tripi

Fabric  
Fiberfill  
High resilient foam  
Fiberfill  
Foam casing  
Pocket spring 4"-5"  
Fibertex  
Metal mesh  
Rigid metal frame

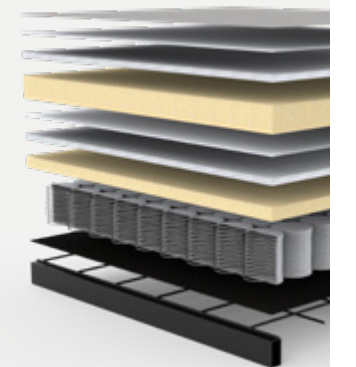

### EXCESS POCKET SPRING

The higher coils in the Excess Pocket Spring models provide a softer sofa comfort. In combination with the core foam casing, the Excess mattress has higher absorption of pressure on each spring for a more comfortable sleep.

The following models have this comfort:  
Cassius D.E.L., Grand D.E.L., Ran D.E.L., Supremax D.E.L.

Fabric  
Fiberfill  
High resilient foam  
Pocket spring 6"  
Fibertex  
Metal mesh  
Rigid metal frame

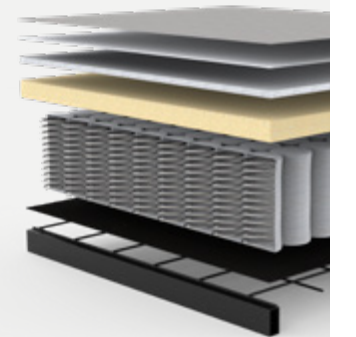



### NO-ZAG SPRING

The solid wood frame with no-zag springs and thick layer of high resilient foam provide an even and soft seating as well as sleeping experience.

The following models have this comfort:  
Cubed Chrome, Cubed Dark Wood, Cubed with arms

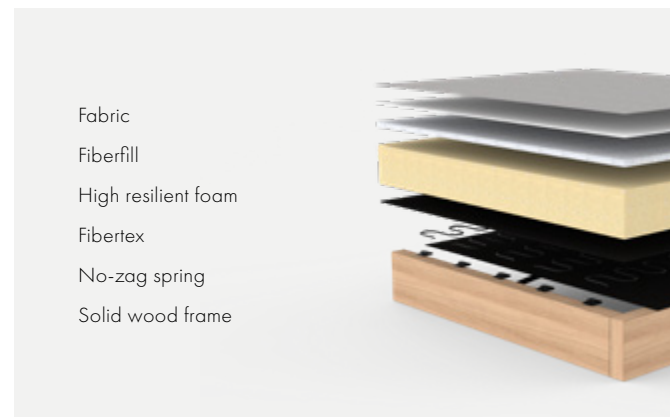

### DOUBLE SPRING

Durable metal frame with a unique combination of no-zag and pocket springs topped with high resilient foam. A mattress construction that offers a soft and inviting top as part of a unique sitting and sleeping comfort.

The following models have this comfort:  
Neah and Vilander

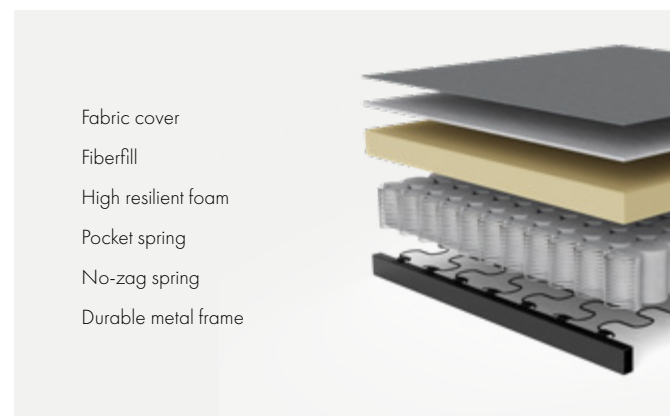

### NO-ZAG AND POCKET SPRING

The combination of a solid wood frame with no-zag and pocket springs with a hyper soft foam on top create a unique softness in seating as well as sleeping position. The use of no-zag spring contributes to an extra layer of elasticity and allows the mattress to breathe.

The following models have this comfort:  
Newilla, Newilla Lounger, Newilla Lounger Chair



### DUAL MEMORY

The Dual Memory mattress features two comforts in one as the mattress is reversible with one side consisting of a 3¼" high density foam whilst the other side consists of 1½" memory foam. Whether you prefer soft or firm comfort this mattress offers both. Further, the cover is removable and can be washed at 140°F/60°C.

Available for:  
Carnell

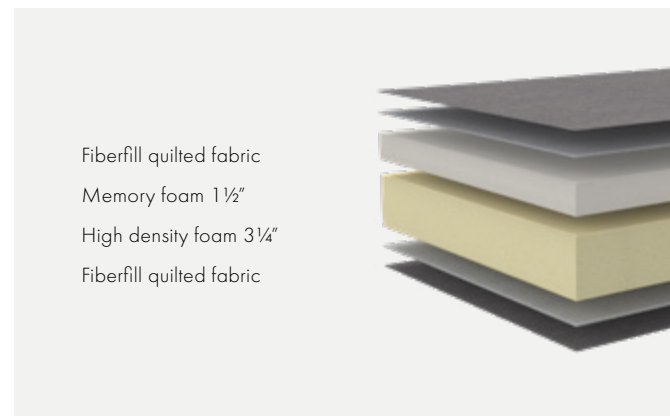

### PILLOW TOPPERS

47"/55"/63"x79".  
A 2" durable and reversible pillow topper with a core of 55 lbs polyether foam that provides an even and supportive resting surface on all adjustable sofa beds. The cover is 100% polyester which is breathable, removable and machine washable at 140°F/60°C.

The pillow topper comes with a wrap for easy storage when not in use. The wrap helps minimize the volume of the topper for better storage.



### FABRIC SPECIFICATIONS

We place high value in ensuring that our fabrics all match the high quality of the design as well as durability of our sofa beds. All fabrics are enhanced with additional backing for extended life time and undergo rigid testing to meet the high standards we impose on our designs and production. All our fabrics are OEKO-TEX® certified.

Name	Composition	Color fastness to light (scale 1-5)	Color fastness to rubbing (scale 1-5)	Martindale	OEKO-TEX®	Machine washable	Water repellent	Performance fabric
Adario	65% Polyester / 35% Recycled polyester	4	4	30.000	•		•	•
Avella	100% Polyester	5	4-5	85.000	•	•		
Bouclé	45% Polyester / 55% Recycled polyester	5	4-5	27.000	•	•		
Blida	80 % Polyester / 20 % Linen	4-5	4-5	100.000	•	•		
Elegance	100 % Polyester	4-5	4-5	60.000	•	•	•	
Halifax	100 % Polyester	4	4	30.000	•		•	•
Kenya	100 % Polyester	4-5	4-5	100.000	•	•		
Melange	100 % Polyester	5	4-5	33.000	•	•		
Micro Check	100 % Polyester	4-5	4-5	27.000	•	•		
Mixed Dance	100 % Polyester	4-5	5	85.500	•	•		
Nist	96 % Polyester / 4 % Linen	4-5	5	100.000	•	•		
Phobos	100 % Polyester	4-5	4-5	100.000	•	•		
Taura	96 % Polyester / 4 % Acrylic	5	4-5	45.000	•	•		
Twist	100 % Polyester	4-5	5	36.000	•	•		
Weda	100 % Polyester	4-5	4-5	100.000	•	•		



Fabric options with approximately 12-14 weeks delivery time.  
Fabric specifications please see page 97.

Stocked fabric options from our US warehouse:  
The individual product pages display the stocked fabric options available from our US warehouse with 2-4 weeks delivery time.

All fabrics on page 98 are machine washable at 86°F/30°C if the sofa bed is designed with detachable covers.

Please note that the printed presentation of the fabric texture and colours may vary from the actual fabric.

Flammability:  
Innovation Living™ products meet the flammability requirements of California Bureau of Household Goods and Services, Technical Bulletin 117-2013 and 16 CFR 1632.

No added flame retardant chemicals/toxins known to the State of California to, or strongly suspected of, adversely impacting human health or development have been used in our products.



For detailed fabric information please scan the QR code.



OUR SELECTION OF PERFORMANCE FABRICS | OUTSTANDING COMFORT WITH A SAFE FINISH

While other brands offer textiles with performance fiber OR finish, LiveSmart combines both to give our fabrics unmatched durability and longevity. LiveSmart fabrics are produced exclusively with performance yarns that are encapsulated with a stain-repellent and moisture-repellent finish for exceptional cleanability. Developed with years of research and testing, LiveSmart technology provides lasting performance at a great value. All our fabrics meet or exceed standards for ASTM performance and safety. Check out our resources page for more information about LiveSmart technology.

ADARIO FABRICS  
CULP LiveSmart Evolve performance fabrics  
65% polyester / 35% recycled polyester

HALIFAX FABRICS  
CULP LiveSmart performance fabrics  
100% polyester



<p>RECYCLED FIBERS</p> <p>Made with 35% recycled fibers. (Only Adario fabrics)</p>	<p>FLUORINE FREE</p> <p>PFAS free fabric that offers protection down to the performance yarn.</p>	<p>MOISTURE REPELLENT</p> <p>Innovative chemistry that repels water and moisture while allowing air to flow freely.</p>	<p>STAIN RESISTANT</p> <p>Stain technology that goes beyond preventing stains to resisting them.</p>	<p>HEAVY DUTY</p> <p>Durability that ensures your fabric looks as beautiful as the day you bought it.</p>
--	---	---	--	---

PROTECTION MADE TO LAST | CLEAN FURNITURE IN AS LITTLE AS THREE STEPS

<p>Step 1: Mix</p> <p>Use a water based soap mixture that combines 1 tablespoon of a liquid detergent such as Tide with 16 ounces of lukewarm water.</p>	<p>Step 2: Blot</p> <p>Dampen the cleaning cloth in the mixture and gently blot the soiled area. Avoid rubbing the affected area aggressively.</p>	<p>Step 3: Rinse</p> <p>Rinse the area with a clean, damp cloth to ensure that all of the soap residue has been removed.</p>
--	--	--

<p>Liquid spills</p> <p>Stains, wine, coffee, milk, blood, soda, beer, urine, tea, juices, Kool-Aid.</p>	<p>Non-liquid spills</p> <p>Ketchup, ice cream, chocolate syrup/chocolate, salsa, jelly, Crayola magic marker, dirt/mud, pizza sauce, nacho cheese.</p>
--	---

For superior cleanability, LiveSmart fabrics combine unmatched stain resistance and moisture repellency. Watch your spills bead up, as our innovative barrier protection prevents messes from penetrating fabric. Cleanup is transformed to an easy swipe of a paper towel. \* The removal of dried non-liquid spills may require the use of a soft brush or butter knife on the affected area before following with wet treatment.



# EXPAND YOUR LIVING SPACE

## Follow us on

[instagram.com/innovationlivingusa](https://www.instagram.com/innovationlivingusa)  
[facebook.com/innovationliving](https://www.facebook.com/innovationliving)  
[linkedin.com/company/innovation-living](https://www.linkedin.com/company/innovation-living)  
[pinterest.com/innovationtm](https://www.pinterest.com/innovationtm)

[www.innovationliving.us](http://www.innovationliving.us)

